

STM32F407VG16 Rev. Z

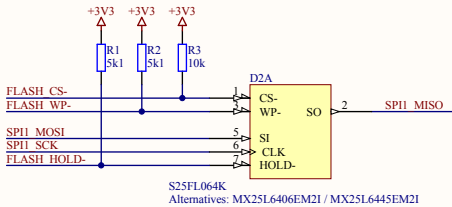

64Bit Flash Memory

This work is licensed under a Creative Commons Attribution-ShareAlike 3.0 Unported License. <http://creativecommons.org/licenses/by-sa/3.0/>

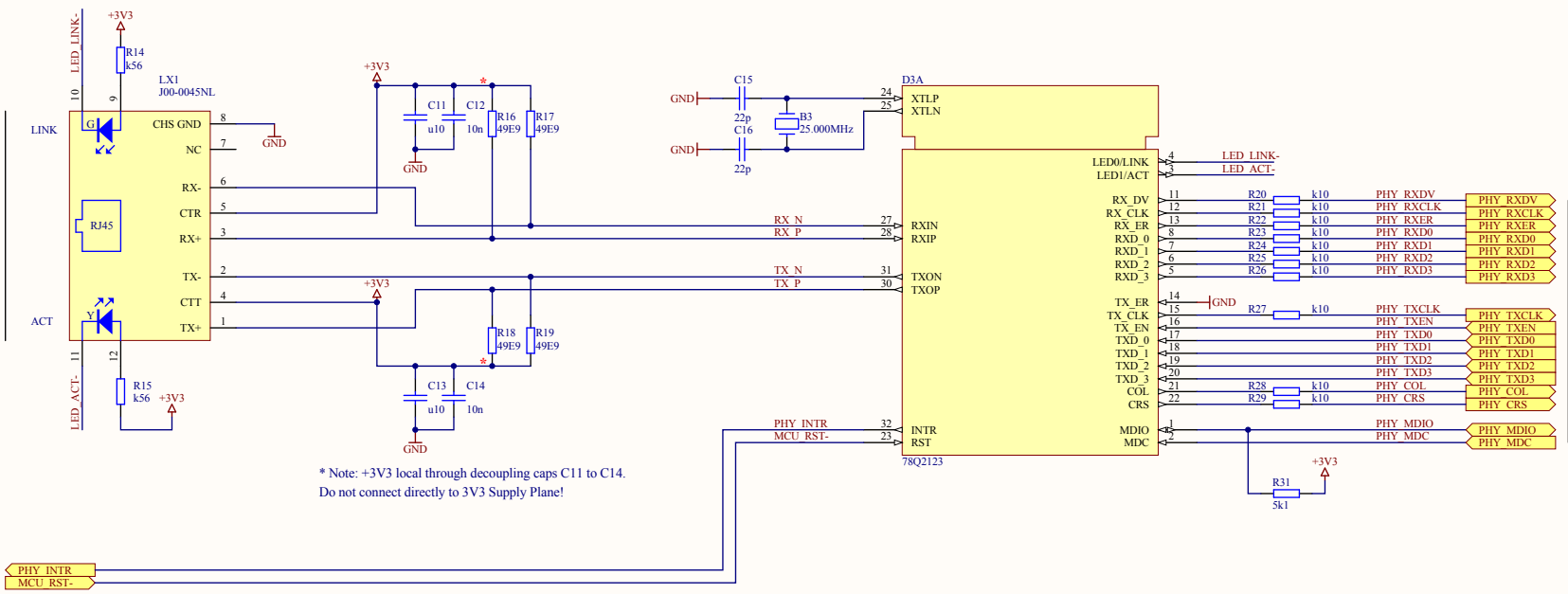

* Note: +3V3 local through decoupling caps C11 to C14.
Do not connect directly to 3V3 Supply Plane!

This work is licensed under a Creative Commons Attribution-ShareAlike 3.0 Unported License.
<http://creativecommons.org/licenses/by-sa/3.0/>

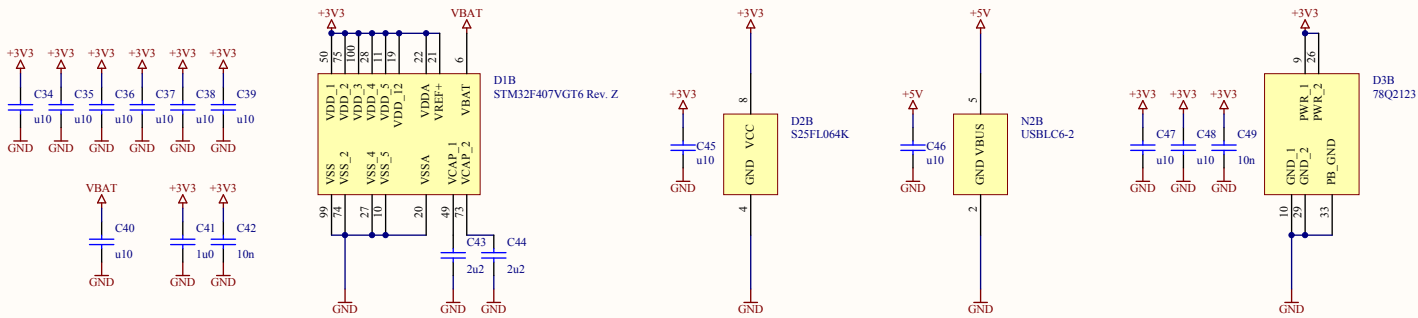
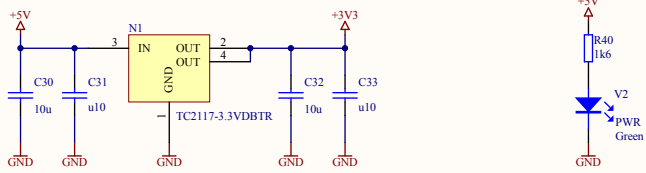



 This work is licensed under a Creative Commons Attribution-ShareAlike 3.0 Unported License.

<http://creativecommons.org/licenses/by-sa/3.0/>



The Mountaineer Group  Rock-Solid Engineering Services



Gezeichnet czi	Geprueft hae	Gesehen Datum
Datum 06.02.2012	Datum 26.03.2012	

Ethernet Mainboard
 .NET Gadgeteer compatible Platform

Power Supply

Version: 1.0

Projektkürzel: MBETH
Blatt: 3 / 4
Nr. CSA-GADP-MBETH-001

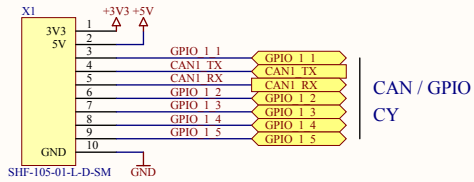

CAN / GPIO
CY

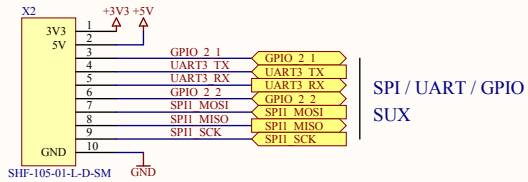

SPI / UART / GPIO
SUX

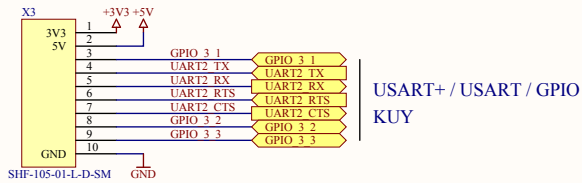

USART+ / USART / GPIO
KUY

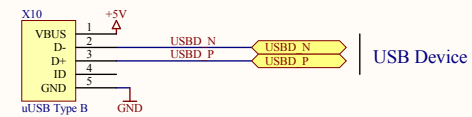

USB Device

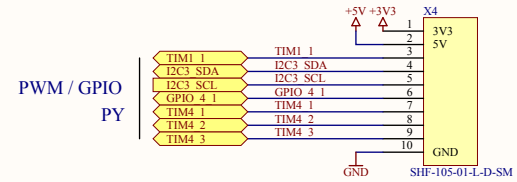

PWM / GPIO
PY

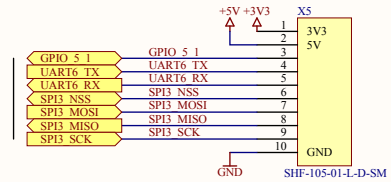

SPI / UART / GPIO
SUY

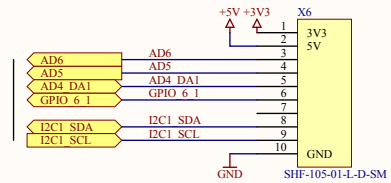

AD / I2C / DA / GPIO
AIOX

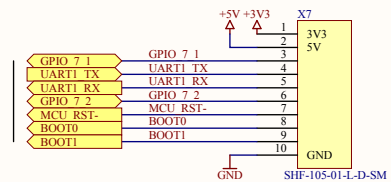

UART / GPIO
UX

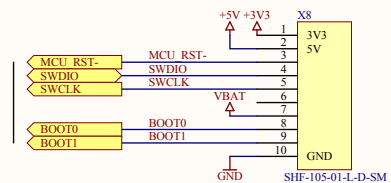

DEBUG
Z



This work is licensed under a Creative Commons Attribution-ShareAlike 3.0 Unported License.
<http://creativecommons.org/licenses/by-sa/3.0/>



The Mountaineer Group Rock-Solid Engineering Services



Gezeichnet czi	Gepreucht hae	Gesehen
Datum 06.02.2012	Datum 26.03.2012	Datum

Ethernet Mainboard
.NET Gadgeteer compatible Platform

Projektkürzel: MBETH
Blatt: 4 / 4
Nr. CSA-GADP-MBETH-001

Connectors Version: 1.0